

BHHZ0400C

General					
Refrigerant	Voltage	Compressor Type	Compressor Model	HP	Listings
R-404A	200-230/60/3	HERMETIC	CS27K3E-TF5	4HP	UL/CUL
Capacity (Btuh)					
At Room Temp. With a 10° TD, 90° Ambient					
-20	-10	0	30	35	40
				32827	36474
At Room Temp. With a 10° TD, 100° Ambient					
-20	-10	0	30	35	40
				29928	
At Room Temp. With a 10° TD, 110° Ambient					
-20	-10	0	30	35	40
				25077	

Dimensional Data				
Overall			Base Size	Base/Hood
L	W	H		
47	36	36	C	940/940

Installation				
Wt. Lbs.	Receiver Tank 90%/90°F	Connections Liquid	Suction	Refrigerant
510	41.5	5/8	7/8	R-404A

Electrical							
MCA	MOP	comp volts	comp phase	comp hz	comp RLA	comp LRA	other volts
24	35	200/230	3	60	15.6	82	208/230
fan phase	fan hz	fan FLA	fan HP	fan quantity	other load phase	other load amps	Approximate Sound Level (Db)
1	60	2.9	1/3	1	1	0.5	76

max evap fan amps	max evap def heater amps	Total Heat Rejection BTUH
0	0	41362

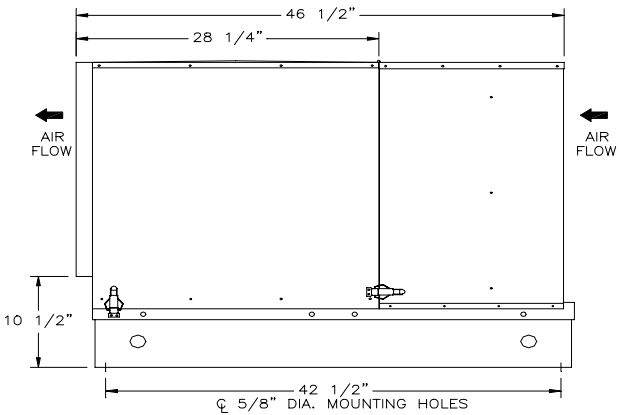
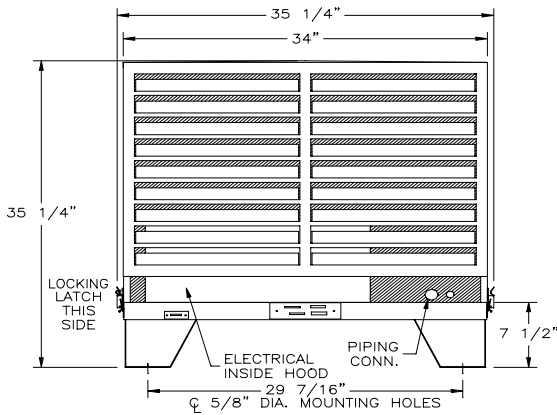

CONDENSING UNITS & REFRIGERATION SYSTEMS