

BHHZ0300C



General					
Refrigerant	Voltage	Compressor Type	Compressor Model	HP	Listings
R-404A	200-230/60/3	HERMETIC	CS20K6E-TF5	3HP	UL/CUL

Capacity (Btuh)					
At Room Temp. With a 10° TD, 90° Ambient					
-20	-10	0	30	35	40
				26396	29329

Dimensional Data				
Overall			Base Size	Base/Hood
L	W	H		
47	36	36	C	940/940

Installation				
Wt. Lbs.	Receiver Tank 90%/90°F	Connections Liquid	Suction	Refrigerant
405	41.5	1/2	7/8	R-404A

Electrical							
MCA	MOP	comp volts	comp phase	comp hz	comp RLA	comp LRA	other volts
18	25	200/230	3	60	11.4	75	208/230

fan phase	fan hz	fan FLA	fan HP	fan quantity	other load phase	other load amps	Approximate Sound Level (Db)
1	60	2.9	1/3	1	1	0.5	76

max evap fan amps	max evap def heater amps
0	0

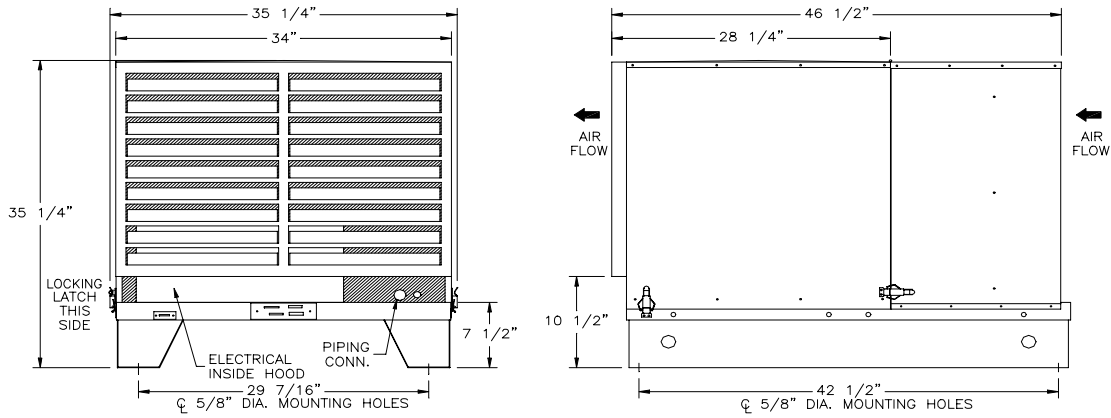

CONDENSING UNITS & REFRIGERATION SYSTEMS